

PARANS



PLT-6

Sunlight System Product Manual

PARANS—Leading natural sunlight



▲ Sunlight Projector

Contents

Parans Natural Sunlight System Overview	01
PLT-6 Natural Sunlight System	02
Product Features	02
Spectral Composition	03
Technical Specifications	04
Energy Fiber	05
Sunlight Fixture	06
Application Scenarios	08
Application Case	09
Installation Methods	15

A Parans Natural Sunlight System Overview

Parans delivers zero-carbon natural sunlight to indoor environments and buildings through industry-leading fiber optic light guiding and solar tracking technology. The system captures and directs natural sunlight into and through the home - deep into the building and away from the windows - and spreads the light in a way that creates an unforgettable experience that improves and enhances the living environment.



B PLT-6 Sunlight System

The PLT-6 is Parans' latest model, specifically designed for the residential market. It builds on the exceptional quality of the PLT-5 and PLT-5E models with significant enhancements in various aspects, aiming to deliver the highest quality natural sunlight to any sunlight-deficient area in the home, including basements, north-facing rooms, bedrooms, closets, living rooms, kitchens, and bathrooms.

Product Features

Appearance Upgrade

Tapered base design for easier installation and simpler operation.

The zoom sunlight projector enhances usability flexibility

The position, direction, and light spot of natural sunlight projection can be adjusted according to the customer's needs, significantly expanding the application range and flexibility of natural sunlight. For example, the sunlight beam can be compressed and focused for body massage and therapy, or directed onto a bed for drying bedding, and so on. Additionally, the zoom spotlight design eliminates the need for complex light cable routing and fixture installation issues.

DIY design, extraordinary experience

The light collector, energy fiber optic cable, and sunlight projector are connected using standard SMA905 or similar fiber optic connectors, making it ideal for a "DIY lifestyle" that encourages creativity, providing customers, especially children, with an extraordinary scientific experience.

Ready to use, easy setup

The sunlight collector features a weighted base, allowing for easy installation without the need for construction work. It is especially suitable for placement in applications such as courtyards, balconies, and indoor floors.

High-precision solar sensor

Solar sensor upgrade, with 0.01-degree solar tracking accuracy and a continuous, stable light spot without any flickering.

No maintenance required

Fully automated software with smart control, plug and play. Easy operation, no additional manual intervention needed.

Full natural sunlight

Spectral range: 230nm-3000nm, providing full natural sunlight; equipped with UV and IR filters, allowing customers to choose between full-spectrum sunlight or visible light only.



Spectral composition

Parans sunlight is fully derived from natural sunlight

Parans sunlight is entirely derived from natural sunlight, collected and transmitted through Parans' high-fidelity optical system, essentially retaining all spectral components of natural sunlight. It's genuine natural sunlight! This is unparalleled by semiconductor LED sources or any other traditional electrical light sources!

Spectrogram

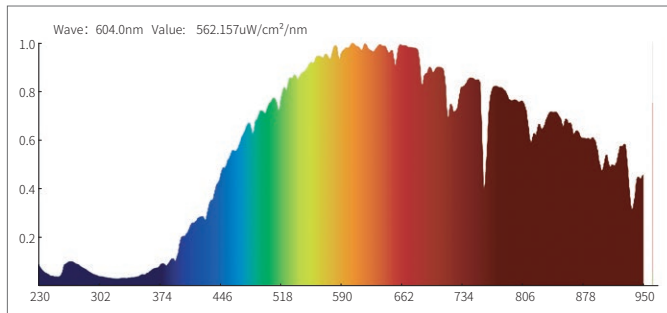

Parans sunlight

Spectrogram

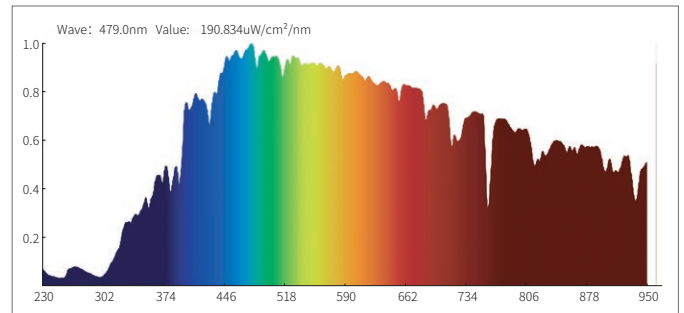

Natural sunlight



Sunlight Collectors

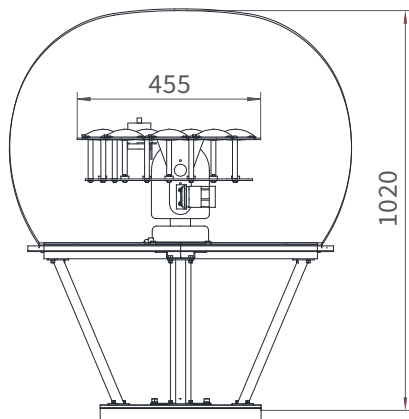
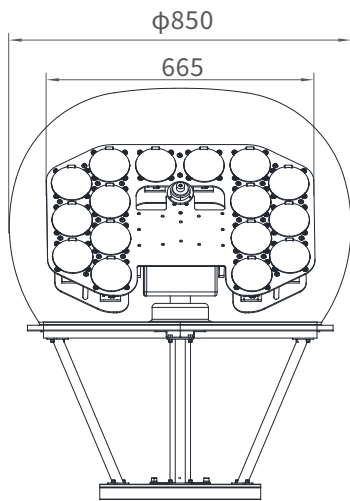

Name	Specifications	Remarks
L * W * H (mm)	850*850*1020	
Weight (Kg)	40	
Quantity of fibers/lenses (pcs)	16	
Output solar power (W)	83 ~ 112	Only applicable to glass fiber Plastic fiber is 1.5 times more than glass fiber
Output visible flux (lm)	5600 ~ 8800	Only applicable to glass fiber Plastic fiber is 2 times more than glass fiber
Output wavelength (nm)	glass fiber: 150nm ~ 2000nm plastic fiber: 425nm ~ 700nm	Selectable spectrum range
Adjustable range of divergence angle	15 ~ 55 degree	Adjustable projection angle range
Adjustable range of spot intensity	0.5 ~ 5 times solar power	Adjustable light intensity range
Fiber core diameter and numerical aperture	glass fiber: OD = 1.2mm, NA = 0.48 plastic fiber: OD = 2.0mm, NA = 0.50	
Max. fiber length (m)	glass fiber: 500m plastic fiber: 50m	Attenuation loss confined
Minimum bend radius of the fiber (mm)	glass fiber: 180mm plastic fiber: 20mm	
Power supply & consumption	AC 110 ~ 250V, 50 ~ 60Hz; 0 ~ 5W	Optional photovoltaic power generation
Operating temperature (°C)	-40 ~ +60	
Relative humidity (%RH)	0 ~ 85%RH	
Material	Aluminum, Steel, Glass, PMMA	
IP rating(electronics)	IP66	

*All values are based on:

1) Standard 30 meters fiber cable ; 2) Solar illuminance of 100000 Lux, sunny day without smog.

Energy Optical Fibers

Glass Optical Fiber & Plastic Optical Fiber

• Fiber Optic Technical Specifications

Characteristics	Glass fibers	Plastic fibers
Fiber structure	Step index	Step index
Numerical aperture	0.48+/-0.02	0.50+/-0.02
Core material	Glass	PMMA
Core OD (mm)	1.2	2
Attenuation Loss	0.01dB/m@600nm	0.1dB/m@600nm
Bending radius (mm)	>180	>20
Operating temperature (°C)	-65 to +140	-50 to +70
Output light (nm)	150 to 3000	425 to 700
Cost	High	Low
Cladding layer	Hard polymer	N/A
Standard buffer	Tefzel	Black polyethylene

• Comparison of Spectral Characteristics

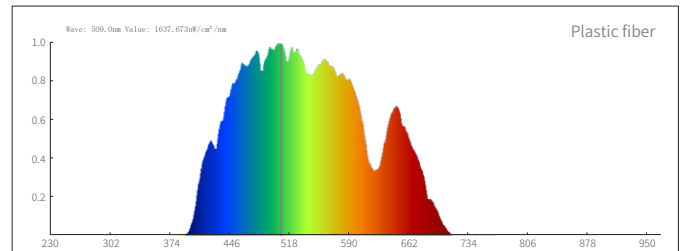
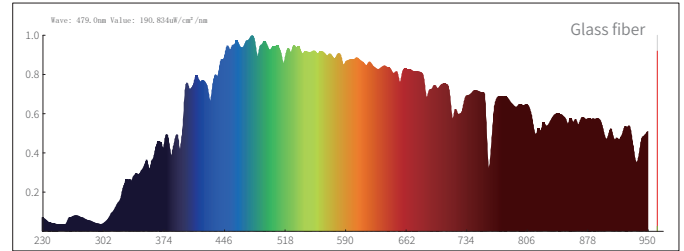

*Glass optical fibers excel in light transmission performance (spectrum range and attenuation) but cost several times more than plastic fibers. Specifically, in short-range visible light applications, plastic fibers offer a better cost-to-performance ratio.

Fiber Optic Connector

• Fiber Optic Jumper/Transmission Network

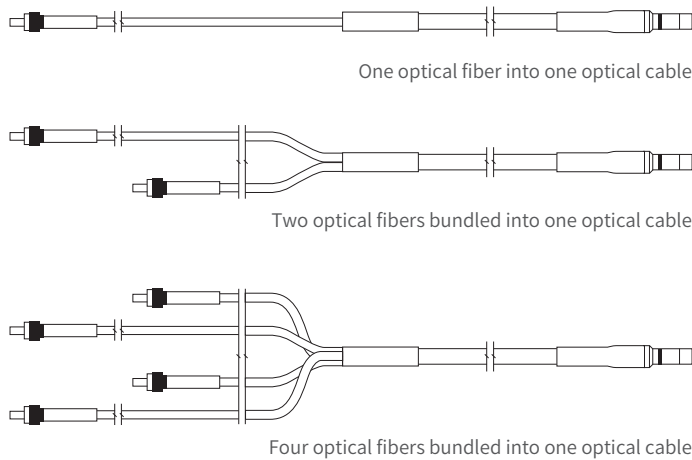

• Inlet Fiber Connector: SMA905 (Industry Standard)

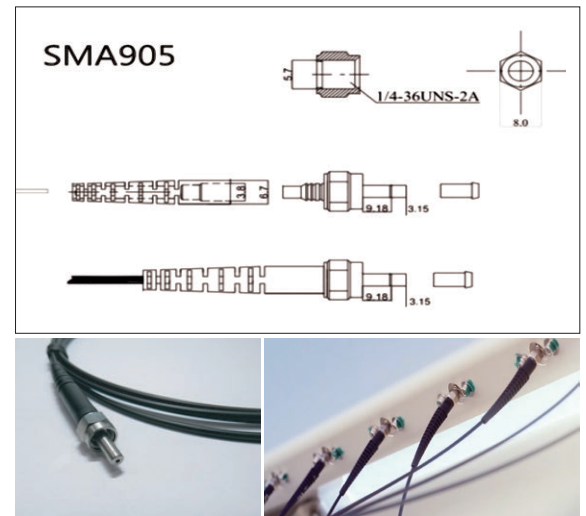

• Output Fiber Connector: 8-core and 16-core fiber connections (Parans standard)

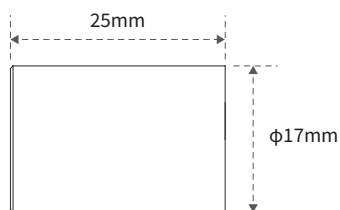

Sunlight Luminaires

Floor-mounted Sunlight Projector

Luminaire Type	Sunlight Projector	Remarks
Model	LDTG01	
Size (mm)	545~1600	
Weight (Kg)	2	
Material	Aluminum/Plastic	
Central axis diameter (mm)	φ15/25	
Storage height (mm)	60	
Connected optical fibers (pcs)	8 , 16	
Light output per fiber (lm)	350 ~ 550	Glass/Plastic Fiber
Light power per fiber (W)	10	Glass Fiber / Full-spectrum
Divergent angle	15 ~ 60°	
Tilt	60°	
Rotate	360°	
Protection rating	IP44	
Mounting	Floor-standing and mobile	
Color	Black	

*All values are based on:

1) Standard 30 meters fiber cable ; 2) Solar illuminance of 100000 Lux, sunny day without smog.



Zoom Sunlight Projector



Luminaire Type	Zoom Sunlight Projector	Remarks
Model	ZDSL-100	
Size (mm)	φ63*150	
Weight (Kg)	0.3	
Material	Aluminum + PMMA	
Embedding Depth (mm)	250	
Connected optical fibers (pcs)	2 ~ 4	
Light output per fiber (lm)	350 ~ 550	Glass / Plastic Fiber
Light power per fiber (W)	10	Glass Fiber / full-spectrum
Divergent angle	15 ~ 50°	Freely Adjustable
Tilt	-60 ~ +60°	
Rotate	360°	
Protection rating	IP44	
Mounting	Track/Surface Mounted with Screws	
Ceiling type	Suspended Ceiling	
Color	White/Black	

*All values are based on:

1) Standard 30 meters fiber cable ; 2) Solar illuminance of 100000 Lux, sunny day without smog.



C Application Scenarios and Cases

Application Scenarios

Parans Sunroom consists of four parts: Sunlight Illumination, Sunlight Hygiene, Sunlight Ecology, Sunlight Massage.



Sunlight Illumination



Sunlight Hygiene

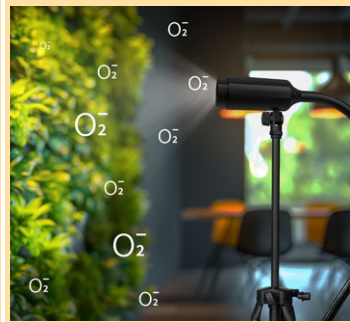

Sunlight Ecology

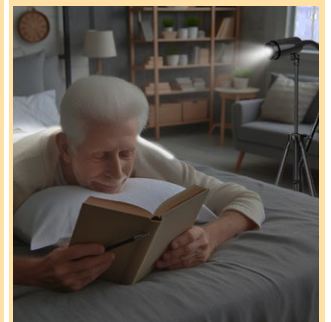

Sunlight Massage

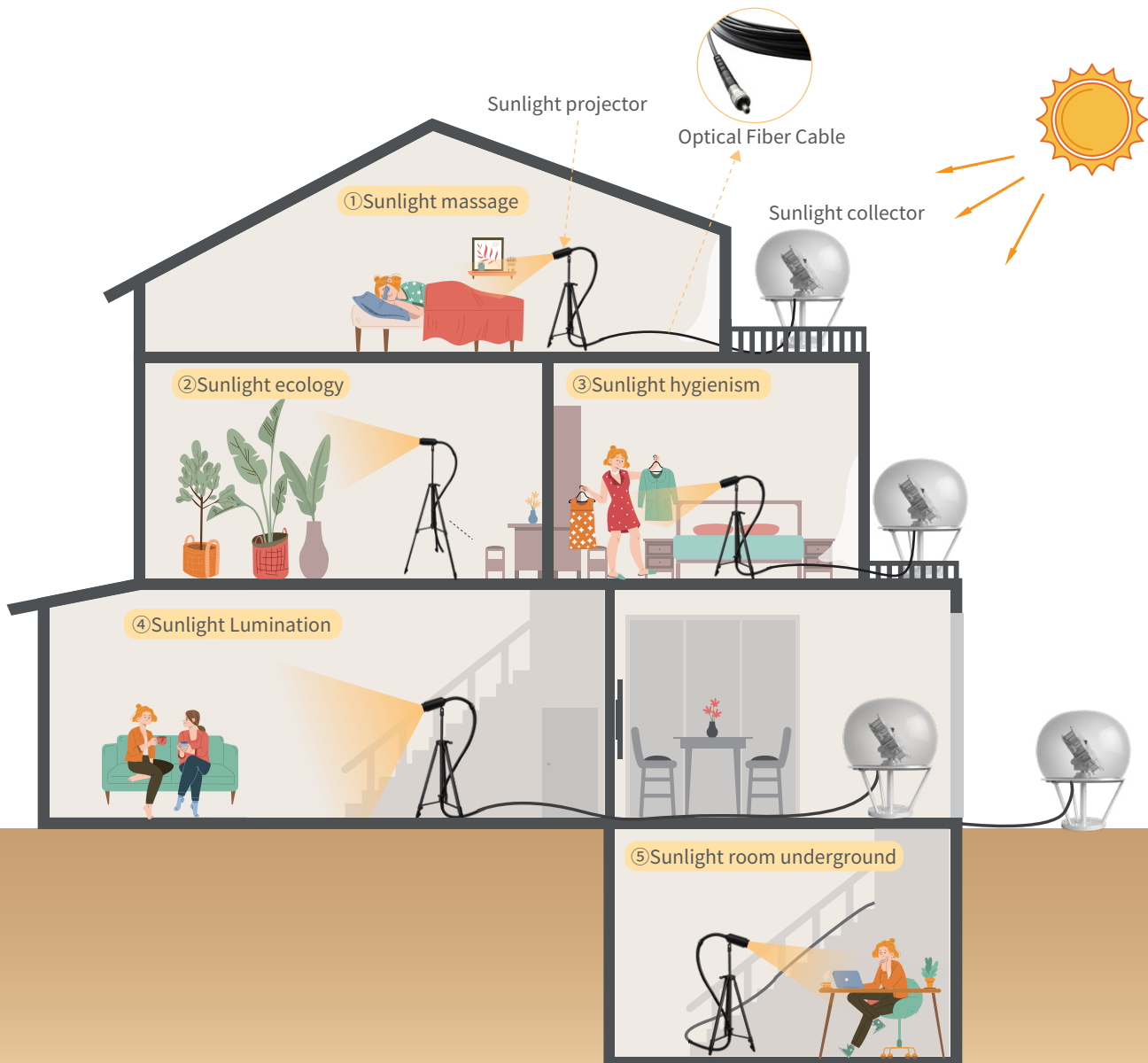

Application Cases

PLT-6 Sunlight System Villa Project in China

In a modern villa in China, the Parans PLT-6 sunlight system was chosen to enhance the natural lighting inside the home. Due to design limitations, certain areas of the villa were not receiving adequate sunlight, and the client sought an innovative solution to improve the indoor lighting environment and increase natural light exposure.

To meet this need, the Parans PLT-6 sunlight system was successfully installed. The system uses advanced fiber optic technology to channel natural sunlight from outside into the villa, and custom sunlight projector direct the light precisely into specific indoor areas. The position, direction, and size of the light spots can be easily adjusted according to the client's needs, offering a highly personalized lighting solution. For instance, the light spot can be reduced for localized light therapy or focused on the bed to provide comfortable lighting while also helping to dry bedding and other fabrics.

The PLT-6 sunlight projector design ensures even light distribution while avoiding the complexity of traditional wiring and fixture installation, making the system easy to install and efficient to operate. With this system, the villa now enjoys a more natural and brighter lighting environment, improving the indoor lighting conditions and enhancing the comfort and health of the living space.

This project showcases the exceptional application of the Parans PLT-6 sunlight system in a villa setting, providing the client with a flexible, intelligent, and seamless natural sunlight solution.

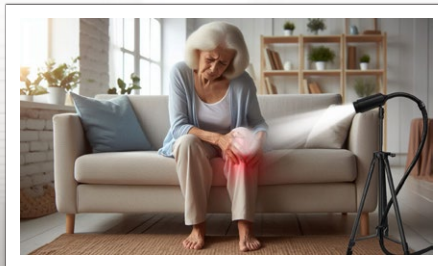
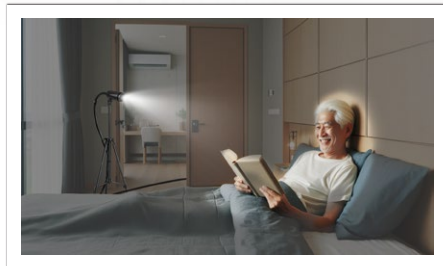

Enhancing the living environment at Marriott Hotel UAE

In modern hotel management, a comfortable living environment is key to attracting guests. The management team at Marriott Hotel UAE observed that due to structural design limitations, rooms like guest suites and dining areas lacked natural sunlight. This not only impacted guest experience but also had a negative effect on the overall ambience of the hotel. After thorough research, Marriott Hotel UAE chose the Parans PLT-6 Sunlight System for its superior performance and easy installation. The PLT-6 system has brought ample natural sunlight into the hotel rooms, effectively solving the issue of insufficient indoor lighting.

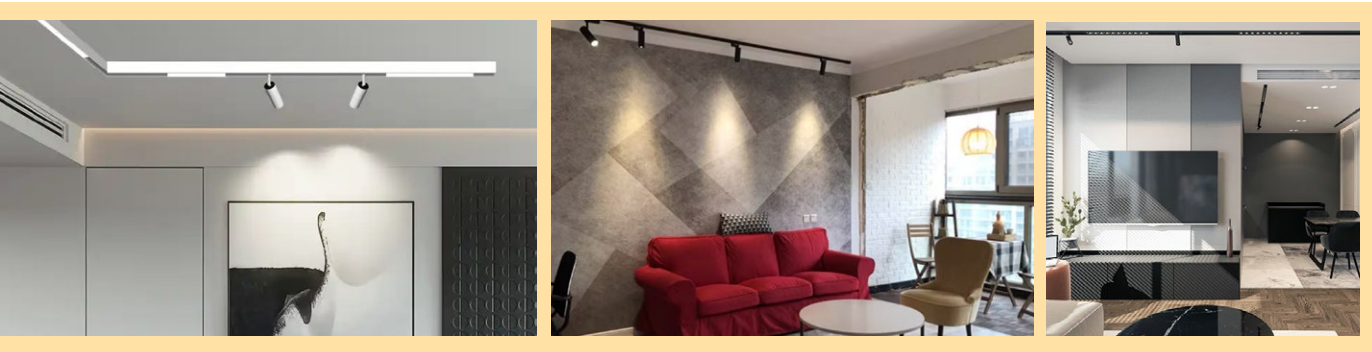

Parans Light Brings Hope to Children in Italy

In Italy, there is a special family with a child who, due to mobility challenges, cannot run and play outside like other children, nor easily bask in sunlight. The father, aware of the importance of sunlight for his child's healthy growth, was determined to find a unique way to bring sunlight into their lives, bringing warmth and joy to his child.

While searching for solutions, he learned about the Parans Natural Sunlight System. After thorough research and comparisons, he chose the PLT-6, a natural sunlight system designed specifically for residential use. The PLT-6 efficiently channels sunlight indoors, creating a healthy light environment that simulates the effects of natural sunlight. The father installed the PLT-6 system, hoping that through this innovative lighting solution, his child could experience the warmth and vitality of sunlight even indoors. With the system in place, the entire home became bathed in warm sunlight, and his child's room turned bright and comfortable, significantly improving the child's quality of life and bringing renewed joy and hope to the family.

This case not only highlights the impressive performance of the Parans Natural Sunlight System in real-world applications but also reflects our commitment to improving lives through technological innovation. Whether for homes, offices, or public facilities, Parans brings bright and natural light to every corner.



PLT-6 Becomes the New Favorite of Romanian Distributors

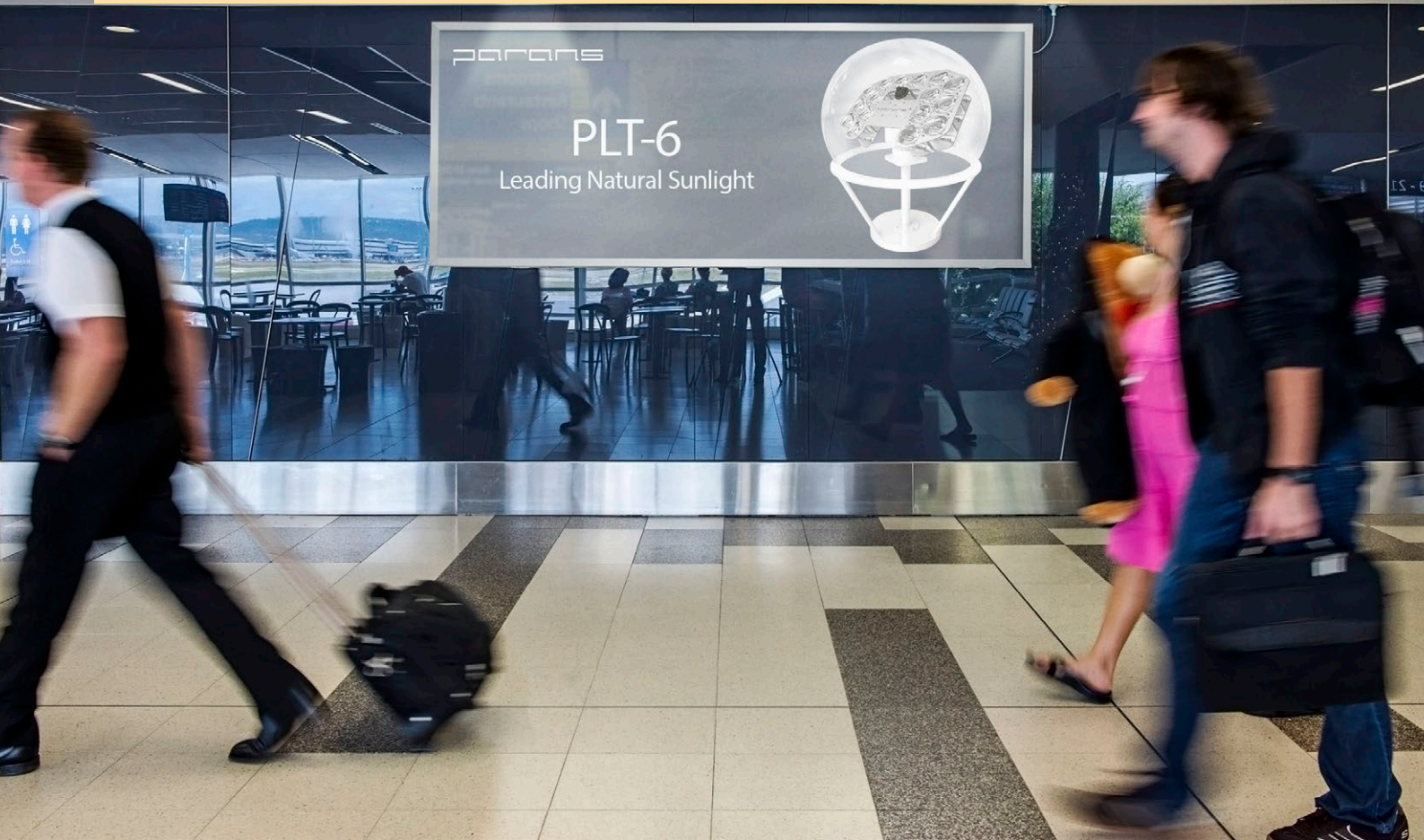

A Romanian distributor has successfully procured our PLT-6 Sunlight System, along with a range of Parans standard fixtures carefully designed by our R&D team. This marks the beginning of a new chapter for sunlight lighting in the Romanian market!

Our partner is a renowned distribution company in Romania, with an extensive sales network and strong market resources. After careful market research and discussions, we decided to collaborate with them to introduce our products to the Romanian market. This distribution company is known for its efficient and professional network, as well as its deep understanding of market trends. We are confident that through this partnership, we can not only effectively enhance our visibility and sales performance in the Romanian market but also bring our innovative products to local consumers, meeting their demand for high-quality products.



Swedish Villa Project

Spacious villa residences are often surrounded by beautiful environments and are typically associated with rooms filled with natural sunlight. Natural light enhances the colors of interior furniture and artwork, creating rooms that make you want to spend long hours in them.

In Sweden, while this villa's architectural design is stunning, almost every room suffers from a lack of healthy sunlight. This is often the result of compromises made between the exterior and interior design of the building. With the Parans system, there is no need to choose between grand architecture and sunlit interiors. The Parans Natural Sunlight System directs sunlight deep into the building, far from the windows, without causing significant disruption to the architectural structure. The Parans PLT-6 Sunlight System is the perfect choice for luxury residences.

Bristol School Project, UK

To bring natural light into the classrooms, the school opted to install the Parans system, using a 60-meter long fiber optic cable to channel natural sunlight into the classrooms. The cables are flexible and thin, requiring only a small hole to bring them into the building. Inside, they occupy a space similar to that of other cables. Within the rooms, the fiber optics are connected to ceiling-integrated diffusers, evenly distributing light throughout the space.

After the installation of the Parans Natural Sunlight System, natural sunlight began to flood into the building. The children bathed in natural light, significantly enhancing their interest in learning and improving their efficiency. Parents have given high praise for the positive impact this has had.

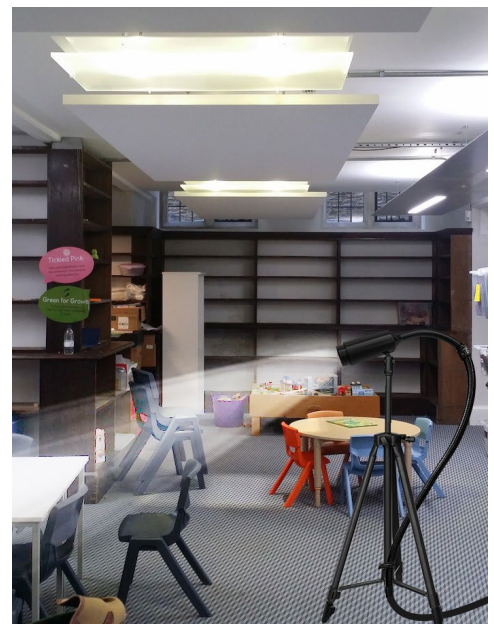

Presbyterian St. Luke's Medical Center Project, USA



The renovation of the neonatal intensive care unit at Presbyterian St. Luke's Medical Center provided an excellent opportunity to bring full-spectrum, healthy natural sunlight into this sensitive medical space, which had previously relied solely on electric lighting. The neonatal unit is located four floors below the roof, and the renovation focused primarily on the exterior, with the fundamental floor, wall, and ceiling structures remaining intact. This meant that no major construction was required for any daylight solution. Additionally, as the neonatal unit is an intensive care environment, it was crucial to avoid the heat gain typically associated with traditional windows.

The Parans system was the perfect and only viable solution. Parans collectors were placed on the roof, continuously tracking the sun throughout the day, and transmitting full-spectrum natural sunlight through fiber optic cables to Parans fixtures, bringing natural daylight into the space.

"They don't use electricity and create beautiful, healthy natural sunlight. I'm very pleased with the results," said Dara Van Essen, Administrator at Presbyterian St. Luke's Hospital.

Maintenance Manager Vic Vigil added, "It works exactly as advertised, delivering full-spectrum natural light where it's needed most, without generating heat and without the costly construction expenses."

Sunshine Hostel Project, Spain

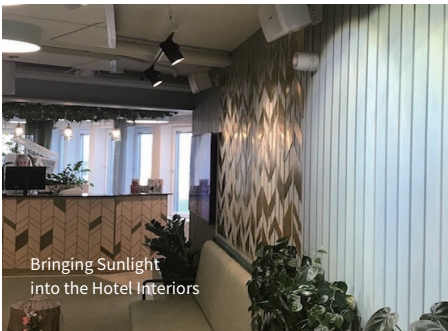

Bringing Sunlight
into the Hotel Interiors



Located in Spain, this hostel has implemented the Parans Sunlight System to provide natural sunlight to 50 landscape plants, enhancing photosynthesis. The system produces 5,000 liters of oxygen daily, reduces 5,000 liters of carbon dioxide, and eliminates hundreds of harmful gases. As a result, it significantly improves the air quality throughout the hostel, turning the entire building into a completely zero-carbon ecological balance system. The hostel not only generates its own oxygen but also has surplus oxygen to supply, truly becoming a "oxygen bar" hostel.

D Installation Method

SCENARIO ① : Sunlight collector and projector are both placed outdoors;

SCENARIO ② : Sunlight collector and projector are placed outdoor and indoor respectively.



SCENARIO ③ : Sunlight collector and projector are both placed indoors.



PARANS

LEADING NATURAL SUNLIGHT



WeChat



YouTube



TIK TOK



Twitter

Parans Light Technology (Qingdao) Co., Ltd

ADD: 798 Wangsha Road
Chengyang District
Qingdao, Shandong 266000
China.

Website: www.paranslight.com

Email: sales@paranslight.com

